



Allseas Spas



**2013**  
**EUROPE**

# PARTS CATALOGUE

— [www.allseasspas.com](http://www.allseasspas.com) —



**Allseas Spas**

EXCELLENT QUALITY COVERS, SEE SEPARATE CATALOGUE

NEW EUROPEAN STANDARD SIZES AVAILABLE

FITS ALL MODELS SPAS

**GLOBAL MARKET MADE!**

Read this page carefully please, to avoid confusion when ordering parts

**PHOTO'S:** Pictures are a representation of the actual part and should be used as a reference only.  
Having difficulties by indentifying a part? When it is difficult to recognize a part from a picture, then mostly there are numbers molded in the plastic parts to identify the parts.

**WARRANTY:** Our warranty policy is according the rules of European Warranty.  
See also: <http://allseasspas.com/?customer-corner.html>

ALLSEAS SPAS STORE  
GLÜCK-AUF-STRAßE 6a  
09599 FREIBERG, GERMANY  
TEL: +49(0) 37328/859381  
FAX: +49(0) 37328/859383  
[service@spa-store.eu](mailto:service@spa-store.eu)

For any question mail to: [service@spa-store.eu](mailto:service@spa-store.eu)  
Owner's manuals, drawings & service guides are all on the website [www.spa-store.eu](http://www.spa-store.eu)



# Allseas Spas

## INDEX

Content	Page	Content	Page
Air Controls & related parts	19-20	Ozonators	38
Aromatherapie box	50-51	Ozone mixing pack	37
Blowers	49	Ozone injector	37
Banners	3	Pillows	53-54
Check valve	17	Pumps pages	33-35
Cover Lock	36	Sandfilter	50
Control panels	40-41,45-48	Sensors	50
Electronics/Balboa	39-41	Skimmer front	15
Electronics/Gecko	43-47	Spa-Vac vacuumcleaner	36
EVA Headrest	53	Sportpack +mounting kit	49
Filters Systems & Filters	20-23	Steps & Handrail	36-37
Fittings	26-30	Swim jet	7-8
Floating filter	15	Tubing	24
Fuses	48	TV Sets Waterproof	42
HEATERS Assemblies/elements	45	UV sanitizer	49
Heat Pumps	54	Valves & Drains	16-18
Jet bodies & internals pages	4-13	Venturi	37
I-Pod	42	Waterfall	14
Lighting	30-32	Water Features	14-15
Manifolds	25		

**BANNERS**

PART NUMBER	DESCRIPTION
-------------	-------------

01.05.01.0354 INTERBAD Banner (Spa 2400mm\*2500mm)



01.05.01.0355 INTERBAD Banner (swim spa 2400mm\*2500mm)



01.05.01.0356 INTERBAD Banner (spa 2000mm\*1250mm)



01.05.01.0357 INTERBAD Banner (swim spa 2000mm\*1250mm)



98.04.0018 Towel with Allseas Spas logo



### Jet bodies & Internals

PART NUMBER	DESCRIPTION
-------------	-------------

212-0090	Ozone jet body 3 /8" RB Air x 3/4" RB water 1/4"orifice
----------	---



PART NUMBER	DESCRIPTION
-------------	-------------

212-0580	Ozone jet ell body 3/8" Air x 1/2" S water
----------	--



PART NUMBER	DESCRIPTION
-------------	-------------

215-9867	OZON Cluster Wallfitting small 38mm
212-9870	OZON Cluster Jet Internal (S/S) small 38mm
711-9860	Grommet Gasket Ozone Cluster Jet 38mm



PART NUMBER	DESCRIPTION
-------------	-------------

212-1550G	Cluster storm jet body 3/8"RB x 3/4"RB
212-1720G	Cluster storm jet body 3/4" RB x No Air



PART NUMBER	DESCRIPTION
-------------	-------------

212-1507	Cluster Storm Jet directional grey 51mm
212-1507S	Cluster Storm Jet directional grey Stainless Steel 51mm
229-1507S	Cluster Storm Jet directional Thread, Stainless Steel 51mm



PART NUMBER	DESCRIPTION
-------------	-------------

212-1679S-DSG	Cluster Storm Jet Directional swirl S/S dark silver glitter 51mm
---------------	--



PART NUMBER	DESCRIPTION
-------------	-------------

226-1507S	Cluster Storm Direct Int. MTL 51mm
-----------	------------------------------------



### Jet bodies & Internals

PART NUMBER	DESCRIPTION
-------------	-------------

212-0149S-DSG	Cluster Storm Jet rifled swirl S/S dark silver glitter 57mm
---------------	---



PART NUMBER	DESCRIPTION
-------------	-------------

226-0149S-DSG	Cluster Storm Rifled INT Swirl 57mm
---------------	-------------------------------------



PART NUMBER	DESCRIPTION
-------------	-------------

212-0310	Storm jet body 3/4" RB x 3/8" RB
212-0300	Mini storm jet body 3/4" RB x 3/8" RB
718-6900	NUT, MINI STORM JET
711-6900	Gasket Grommet Mini Storm Jet



PART NUMBER	DESCRIPTION
-------------	-------------

212-0360	Mini storm jet body 3/4" RB no Air
----------	------------------------------------



PART NUMBER	DESCRIPTION
-------------	-------------

212-7927	Mini storm jet directional grey 76mm
212-7927S	Mini storm jet directional grey/SS chrome 76mm



PART NUMBER	DESCRIPTION
-------------	-------------

212-8449S- DSG	Mini Storm Jet Directional swirl S/S dark silver glitter 76mm
----------------	---



PART NUMBER	DESCRIPTION
-------------	-------------

212-7827S	Large-Face Mini Storm Jet directional polished S/S 84mm
-----------	---



### Jet bodies & Internals

PART NUMBER	DESCRIPTION
212-6927	Mini Storm II 5 point scalloped grey 76mm
212-6927S	Mini Storm II gray with stainless steel 76mm



### PENT-AIR JETS

PART NUMBER	DESCRIPTION
9653WW	Cyclone jet micro, directional 76mm
90015800	Stainless Esc 76mm
944601WW	Luxury Jet Emerald directional. 89mm
9844WW	Luxury Cyclone jet Internal, directional 89mm
9846WW	Luxury Cyclone jet Internal, directional Swirl 89mm
989800	Stainless Esc 89mm
973300	Stainless Esc 98mm
944530WW	Cyclone jet directional 127mm
944511WW	Cyclone jet 127mm, swirl grey
9510WW	Cyclone jet 127mm, Twin Spin
940012	Stainless Esc 127mm



Pent air jets



Stainless Esc 127mm

### Jet bodies & Internals

PART NUMBER	DESCRIPTION
212-7807	Mini storm jet Massage grey directional 76mm
212-7807S	Mini storm jet Massage grey/SS massage, Metal 76mm
212-8469S-DSG	Mini Storm Jet Massage swirl S/S dark silver glitter 76mm



### Jet bodies & Internals

PART NUMBER	DESCRIPTION
-------------	-------------

212-8377	Mini storm jet Multi Massage grey 76mm
----------	--



212-8377S	Mini storm jet Multi Massage Stainless Steel 76mm
-----------	---

PART NUMBER	DESCRIPTION
-------------	-------------

212-0199S-DSG	Mini Storm Jet Rifled Swirl S/S 76mm
---------------	--------------------------------------



PART NUMBER	DESCRIPTION
-------------	-------------

222-1157GSM	Mini Jet Body 1/2"Sx3/8"B SAME SDE , 1/4"NOZZ
-------------	---



PART NUMBER	DESCRIPTION
-------------	-------------

224-3167 S/S	Mini Jet Directional Large face smooth 76mm
--------------	---



PART NUMBER	DESCRIPTION
-------------	-------------

212-0157S	Mini Storm Jet Rifled Internal 76mm
-----------	-------------------------------------



PART NUMBER	DESCRIPTION
-------------	-------------

210-8279G-DSGS	N/ADJ MASTER MASSAGE JET 1 1/2"Sx 1/2"S Swirl 7 3/4" / 197 mm
----------------	--











PART NUMBER	DESCRIPTION
-------------	-------------

210-7157	Master Massage Jet 7 3/4" / 197 mm Grey 1/2" S x 1 1/2" S with Grommet Gasket
----------	--







## Jet bodies & Internals



PART NUMBER	DESCRIPTION	
212-6827	Jumbo Roto Storm Jet Internal grey	
PART NUMBER	DESCRIPTION	
01.03.04.0075	Large Face 1" Direct Jet Insert-S/Steel-Pearl grey RD611-1023S	
PART NUMBER	DESCRIPTION	
01.03.04.0080	2.5"Jet internal-Directinal-Scallop face-S/Steel face-Screw in RD203-2313SC	
01.03.04.0081	2.5" Jet internal-Scallop face-Single pulse-S/Steel face-Screw in RD203-2413SC	
PART NUMBER	DESCRIPTION	
01.03.04.0078	2" Jet Internal-Scallop face-Directional-S/Steel face-Screw in RD223-2313SC	
01.03.04.0079	2" Jet Internal-Scallop face-Spinning-S/Steel face-Screw in RD223-2413SC	
PART NUMBER	DESCRIPTION	
01.03.04.0083	3"Jet internal-Scallop face-Single pulse-S/Steel face-Screw in RD213-3413SC	
01.03.04.0086	Large 3" Jet internal-Scallop face-Single pulse-S/Steel face-Screw in/RD203-3413SC	
01.03.04.0084	3"Jet internal-Scallop face-Twin pulse-S/Steel face-Screw in RD213-3423SC	
01.03.04.0087	Large 3" Jet internal-Scallop face-Twin pulse-S/Steel face-Screw in RD203-3423SC	
01.03.04.0082	3"Jet internal-Directinal-Scallop face-S/Steel face-Screw in RD213-3713SC	
01.03.04.0085	Large 3" Jet internal-Directinal-Scallop face-S/Steel face-Screw in RD203-3713SC	
PART NUMBER	DESCRIPTION	
01.03.04.0089	4"Jet internal-Scallop face-Single pulse-S/Steel face-Screw in/RD203-4413SC	
01.03.04.0090	4"Jet internal-Scallop face-Twin pulse-S/Steel face-Screw in RD203-4423SC	
01.03.04.0088	4"Jet internal-Directinal-Scallop face-S/Steel face-Screw in RD203-4313SC	

### Jet bodies & Internals

PART NUMBER	DESCRIPTION	
01.03.04.0093	5"Jet Internal-Scallop face-Single pulse-S/Steel face-Screw in/RD203-5413SC	
01.03.04.0094	5"Jet internal-Scallop face-Twin pulse-S/Steel face-Screw in RD203-5423SC	
01.03.04.0092	5"Jet Internal-Scallop face-Directional-S/Steel face-Screw in/RD203-5713SC	
01.03.04.0095	5" Jet Internal-Scallop face-Twin pulse-Multi-port face-S.S faceScrew in/RD213-5823SC	

PART NUMBER	DESCRIPTION	
01.03.04.0104	Swim Jet with inner diameter 38mm - Force 10 - with S/Steel Trim - Dark Gray	
01.03.04.0139	Australian Swim jet reducer - diameter 25mm	

PART NUMBER	DESCRIPTION	
01.03.04.0105	Waterway swim jet - S/Steel - Gray(210-3927S)	
01.03.04.0113	5" Swim jets-CMP Volcano Jet	

PART NUMBER	DESCRIPTION	
01.03.04.0054	Large 1" Jet assembly--plastic--Pearl grey	
01.03.03.0120	1" Air Injector body/RD201-1001-Ozone system	
01.03.04.0130	Swim jet with inner diameter 25mm - Force 10 - with S/Steel Trim - Dark Gray	
01.03.03.0170	Therapy Air Injector Tee-RD612-1001	
01.03.04.0055	1" Air Injector Assembly-Multi-flow-Plastic face,Pearl Grey-Single way/RD612-1133(A)	

### Jet bodies & Internals

PART NUMBER	DESCRIPTION
-------------	-------------

212-6827S	Jumbo Roto Storm Jet Internal MTL 191mm
-----------	---



PART NUMBER	DESCRIPTION
-------------	-------------

224-3169-DSG	Mini Jet Directional Large face smooth S/S 76mm
--------------	---



PART NUMBER	DESCRIPTION
-------------	-------------

210-5777	Poly jet body assemblies 3/8"
----------	-------------------------------

210-5757	Poly jet body 3/8" Air x 1/2" S Water
----------	---------------------------------------

210-5759-DSG	Poly jet body 3/8" Air x 1/2" S Water
--------------	---------------------------------------

711-1730	Gasket poly jet grommet
----------	-------------------------



PART NUMBER	DESCRIPTION
-------------	-------------

210-8757	Poly jet internal Monster grey
----------	--------------------------------

210-8759-DSG	Poly jet internal Monster
--------------	---------------------------

916-1250	Stainless Esc.n SS
----------	--------------------



PART NUMBER	DESCRIPTION
-------------	-------------

212-0410	Poly Storm jet body 3/4" S FEMALE RB x 3/8" RB
----------	--

212-0400	Poly Storm jet body 3/4" RB x 3/8" RB
----------	---------------------------------------

718-4100	Nut for Poly Storm Jet body
----------	-----------------------------

711-1730	Gasket poly jet grommet fr Poly Jet Body
----------	--



PART NUMBER	DESCRIPTION
-------------	-------------

212-8057	Poly storm jet internals directional grey 89mm
----------	--

212-8057S	Poly storm jet internals Direc. Metal Esc. Grey 89mm
-----------	--

212-4029S-DSG	Poly Storm Jet Swirl Directional S/S dark silver glitter 89mm
---------------	---



PART NUMBER	DESCRIPTION
-------------	-------------

212-8167S	Large-Face Poly Storm Jet Stainless directional Steel 89mm
-----------	--



### Jet bodies & Internals

PART NUMBER	DESCRIPTION
-------------	-------------

212-0449S- DSG	Poly Storm Jet Swirl Directional S/S large Face dark silver glitter
----------------	---



PART NUMBER	DESCRIPTION
-------------	-------------

212-0619S-DSG	Poly Storm Jet Swirl Rifled S/S Large Face dark silver glitter 101mm
---------------	--



PART NUMBER	DESCRIPTION
-------------	-------------

212-8257	Poly storm II jet internals grey 89mm
----------	---------------------------------------



212-8257S	Poly storm II jet internals gray Stainless Steel 89mm
-----------	---

PART NUMBER	DESCRIPTION
-------------	-------------

212-8037	Poly storm jet internals massage grey 89mm
----------	--

212-8037S	Poly storm jet internals massage greyS/S 89mm
-----------	---



212-4059S-DSG	Poly Storm Jet Swirl Massage S/S dark silver glitter 89mm
---------------	---

PART NUMBER	DESCRIPTION
-------------	-------------

212-8277	Poly storm jet grey Multi Massage 89mm
----------	--

212-8277S	Poly storm jet grey, Multi Massage Chrome 89mm
-----------	--



PART NUMBER	DESCRIPTION
-------------	-------------

212-8197	Poly storm jet internal 89mm no longer available
----------	--

212-8197S	Poly storm jet Galaxy Chrome 89mm
-----------	-----------------------------------





### Jet bodies & Internals

PART NUMBER	DESCRIPTION	
212-1949-DSGS	Poly Storm Jet Swirl Rifled S/S dark silver glitter 95mm	

PART NUMBER	DESCRIPTION	
212-0020	3/4" SB Storm Jet Body	
212-0040	3/4" RB Storm Jet Body	
718-6600	Nut for Power Storm Jet body	
711-6500	Gasket Grommet Power storm	

PART NUMBER	DESCRIPTION	
212-7637	Power storm jet 5-point scallop directional grey 127mm	
212-7637S	Power storm jet directional grey, chrome 127mm	
212-6349-DSGS	Power storm jet Direct Swirl S/S dark silver glitter 127mm	

PART NUMBER	DESCRIPTION	
212-6447	Power Storm II 5 point scalloped grey 127mm	
212-6447S	Power Storm II jet 5 point scalloped grey Stainless Steel 127mm	

PART NUMBER	DESCRIPTION	
212-7747	Power storm jet massage, grey 127mm	
212-7747S	Power storm jet massage, Metal, grey 127mm	
212-6359S-DSG	Power Storm Jet Swirl Massage S/S dark silver glitter 127mm	

PART NUMBER	DESCRIPTION	
212-1999S-DSG	Power Storm Jet Swirl Rifled S/S dark silver glitter 133mm	

PART NUMBER	DESCRIPTION	
212-7517	Power storm jet Multi massage 127mm	
212-7507S	Power storm jet Multi Massage grey Stainless Steel Chrome 127mm	

### Jet bodies & Internals

PART NUMBER	DESCRIPTION
-------------	-------------

640-3257VP Hi-flo Suctions 100GPM 1 1/2"standard nut , Grey

PART NUMBER	DESCRIPTION
-------------	-------------

212-2000 WHIRLPOOL JET BODY w/ flat Gasket 1 1/2"S x 1/2"S



PART NUMBER	DESCRIPTION
-------------	-------------

212-2057 Whirlpool jet adjustable grey



212-2067S Whirlpool jet adjustable grey Mtl. Esc.

PART NUMBER	DESCRIPTION
-------------	-------------

210-8167S MASTER MESSAGE JET 1 1/2"Sx1/2"S 197mm  
Non adjustable, smooth Stainless Steel Escutcheon



PART NUMBER	DESCRIPTION
-------------	-------------

210-6817 Jumbo Roto Storm grey Massage smooth 191mm



210-6817S Jumbo Roto Storm Massage smooth, with S/S 191mm

PART NUMBER	DESCRIPTION
-------------	-------------

01.03.04.0002 Jet body Assembly - 2.5" External 3/4" x 3/8" Screw-in

01.03.04.0001 Jet body Assembly - 2" External 3/4" x 3/8" Screw-in







01.03.04.0003 Jet body Assembly - 3" External 3/4" x 3/8" Screw-in

01.03.04.0004 Jet body Assembly - 4" External 3/4" x 3/8" Screw-in

01.03.04.0005 Jet body Assembly - 5" External 3/4" x 3/8" Screw-in



## Water Features

PART NUMBER	DESCRIPTION	
210-9207	Flash Mount LED Water Feature - Grey	
PART NUMBER	DESCRIPTION	
675-4007	6" Waterfall-assembly grey	
PART NUMBER	DESCRIPTION	
675-4908L	200mm Waterfall-assembly for LED 1 " socked intake	
PART NUMBER	DESCRIPTION	
675-2007S	Pop-Up 180° Waterfall Assembly Metal Cap grey	
675-2009-DSG	Pop-Up 180° Waterfall Assembly	
PART NUMBER	DESCRIPTION	
01.03.03.0131	<a href="#">2" Water diverter valve - Pearl Grey</a>	
PART NUMBER	DESCRIPTION	
01.03.03.0133	<a href="#">1" Air Check Valve Assembly - Pearl Grey</a>	
PART NUMBER	DESCRIPTION	
01.03.03.0135	<a href="#">Air control - Fusiform cover, without adapter, Pearl Grey</a>	
PART NUMBER	DESCRIPTION	
01.03.02.0043	<a href="#">IPS Blue Glue 747-949ML/bottle, can be used Wet-Dry without Primer</a>	
01.03.02.0044	Silicone (Acidity) Used for Lights, panels and underwater connection	
01.03.02.0045	Silicone (Neutrality) can be used for connecting jets	

## Water Features

PART NUMBER	DESCRIPTION
-------------	-------------

01.03.03.0093	Glued Circle for Twin cylinders skimmer
---------------	---



01.03.03.0095	Twin Cilinder Skimmer (carbon grey) -25253-127-000 【 <b>PLS ORDER TOGETHER WITH 01.03.03.0093</b> Gasket of Twin Cilinder Skimmer 】
---------------	---



PART NUMBER	DESCRIPTION
-------------	-------------

01.05.02.0019	Twin Cilinder Skimmer Front Cover Assembly kit
---------------	--

PART NUMBER	DESCRIPTION
-------------	-------------

01.03.03.0099	2" Floating Filter (with basket and gasket)- Pearl Grey - S/S cover
---------------	--



PART NUMBER	DESCRIPTION
-------------	-------------

01.03.04.0076	1" Air Injector Assembly-Multi-flow-S.S face-Single way
---------------	---



PART NUMBER	DESCRIPTION
-------------	-------------

01.03.04.0110	Waterway River Swim Jet - With LED
---------------	------------------------------------



01.05.01.0207	River Stream Swim Jet Face
---------------	----------------------------

PART NUMBER	DESCRIPTION
-------------	-------------

01.03.03.0109	6" Waterfall Body (HT-B44)-clear
---------------	----------------------------------



PART NUMBER	DESCRIPTION
-------------	-------------

01.03.03.0110	8" Waterfall Body (L-2201)-clear
---------------	----------------------------------







## Valves & Drains

PART NUMBER	DESCRIPTION	
640-3330	Hi-flo suctions 100 GPM stainless steel 1 1/2" x standard nut	
640-3587	Super Hi-Flo Suction 200GPM, deep socket	
640-3580S	Super Hi-Flo Suction Stainless Steel 200GPM	
01.03.03.0228	<a href="#">2" Suction (full set) - SS face</a>	
PART NUMBER	DESCRIPTION	
640-4287	1 1/2" 90° ELL LO PRO SUCTION-grey	
640-3259LND SG	HI-FLO SUCT 1-1/2"HEX VGB2008 - DSG W/GROM	
642-4100	1-1/2"S x 2"SPG SUCTION STRAIGHT NUT, ADAP	
640-4467	1"LO-PRO SCTN, 1"S 90o ELL W	
640-4469-DSG	1"LO-PRO SCTN, 1"S 90o ELL W/GRMT GSKT-DS	
PART NUMBER	DESCRIPTION	
640-0427	Low Profile Drain Assembly Shur Grip 3/4" SB	
640-0429-DSG	Low Profile Drain Assembly Shur Grip 3/4" SB	
711-0080	Low Profile Drain Grommet Gasket	
PART NUMBER	DESCRIPTION	
600- 3279DSG-PS	1" Diverter Valve cap DSG, "S" Handle grey (PS)	
PART NUMBER	DESCRIPTION	
600-4237	1" diverter valve 1" S inlet, 1" S outlets Horizontal Style, submersible	
PART NUMBER	DESCRIPTION	
600-3067	3-Port diverter valves Notch Style, 2" S Inlet x 2" S Outlets (2) grey	
916-6090	Trim Ring Stainless Steel	
602-3557	cap for 2" 3 Way Valve notched grey	
602-3547	Handle 2" 3 Way Valve notched grey 2" Diverter Valve	
600-3039DSG-PS	S Style- DSG/SILVER cap DSG "S" Handle gray (PS)	

### Valves & Drains

PART NUMBER	DESCRIPTION	
600-4367	1" ON/OFF Turn Valve single port grey	
600-4319DSG-PS	ON/OFF TURN VLV.SINGLE PORT 2-TONE "S" S	
PART NUMBER	DESCRIPTION	
600-4717	Turn Valve 5-Scallop Shur-Grip 3/4" SB x 3/4" SB	
600-3269DSG-PS	3/4" SB 180° Shut off Valve "S" Style	
PART NUMBER	DESCRIPTION	
880-1500	Slice Valve 1 1/2" S x 1 1/2" Spigot gate valve	
01.03.03.0262	<a href="#">Check valve - 1.5" Slip x 1.5" slip</a>	
880-2020	Slice Valve 2"S x 2"S gate valve	
01.03.03.0197	<a href="#">Check valve - 2" Slip x 2" slip</a>	
PART NUMBER	DESCRIPTION	
600-9101	Lo-Profile Drain Fill Valve	
PART NUMBER	DESCRIPTION	
400-2070	3/4" Hose on/off valve assembly	
PART NUMBER	DESCRIPTION	
01.03.03.0183	Drain Valve - 25212-004	
PART NUMBER	DESCRIPTION	
01.03.03.0184	<a href="#">Blower drain valve</a>	
PART NUMBER	DESCRIPTION	
01.03.03.0185	<a href="#">Blower Check Valve- 1.5", #4150</a>	
01.03.03.0186	<a href="#">1.5" one way valves- white color</a>	

## Valves & Drains

### Air Controls & Related Parts

PART NUMBER	DESCRIPTION
-------------	-------------

01.03.03.0194 1.5" Compact Ball Valve

01.03.03.0195 2" Compact Ball Valve



PART NUMBER	DESCRIPTION
-------------	-------------

01.03.03.0088 Safty Cover of Floating filter (grey)



PART NUMBER	DESCRIPTION
-------------	-------------

01.03.03.0089 Breakwater Assembly



PART NUMBER	DESCRIPTION
-------------	-------------

01.03.03.0090 Connector of Front access Skimmer (Breakwater skimmer)



PART NUMBER	DESCRIPTION
-------------	-------------

660-4417 Air Control True Seal Extra short

660-4417S Air Control True Seal Extra Short S/S grey

660-4459DSG-PS Air Control True Seal 1", S-Style, two tone



PART NUMBER	DESCRIPTION
-------------	-------------

660-3577 1" Top Access Air Control, notched style grey

916-0030 Trim Ring S/S

662-2107 Handle 1" Air Control grey notched



PART NUMBER	DESCRIPTION
-------------	-------------

411-3480 1" Spg x 3/4" SB Ell



PART NUMBER	DESCRIPTION
-------------	-------------

413-1920 3/4" Barb adapter



### Air Controls & Related Parts

PART NUMBER	DESCRIPTION
-------------	-------------

672-6970	Shur-Grip-Manifolds
----------	---------------------

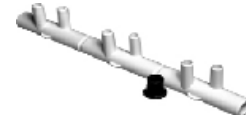

PART NUMBER	DESCRIPTION
-------------	-------------

672-4010	3/8" Barb manifolds 1" Spg x (2) 3/8" with 2 plugs
----------	--

672-4020	3/8" Barb manifolds 1" S x (2) 3/8" with 2 plugs
----------	--

672-4030	1" Spg (4) 3/8" Barbs with 2 Plugs
----------	------------------------------------

672-4040	3/8" Barb manifolds 1" S x (4) 3/8" with 2 plugs
----------	--

672-5060	Manifold 1"S x 1"S x (6) 3/8" Barbs
----------	-------------------------------------

672-5070	Manifold 1"S x 1"S x (8) 3/8" Barbs
----------	-------------------------------------



PART NUMBER	DESCRIPTION
-------------	-------------

223-0010	3/8" Barb adapter Check Valve 1" Spg x 3/4" RB
----------	--



PART NUMBER	DESCRIPTION
-------------	-------------

670-2507	Ozone Air Injector 3/8" grey
----------	------------------------------

670-2557	Single Hole Air Injector 3/8" SB 90 deg. Body Stainless Steel
----------	---

711-0020	Air Injector Grommet Gasket
----------	-----------------------------



PART NUMBER	DESCRIPTION
-------------	-------------

670-2307	Top-flo air injectors 3/8" SB ell style assembly grey
----------	---



670-2390	Top-flo air injectors straight body 3/8" SB ell style assembly w/Stainless Steel Escutcheon
----------	---



PART NUMBER	DESCRIPTION
-------------	-------------

670-2807	Aroma therapy canister grey
----------	-----------------------------



PART NUMBER	DESCRIPTION
-------------	-------------

672-4660	3/8" Barb manifolds 1 1/2" Spg x 1 1/2" Spg x(10) 3/8" Barbs, 4 Plugs
----------	---



## Air Controls & Related Parts

### Filter Systems & Filters

PART NUMBER	DESCRIPTION
-------------	-------------

672-4610	3/8" Barb manifolds 1 1/2" S x blind hole x (4) 3/8" smooth barbs
----------	---



PART NUMBER	DESCRIPTION
-------------	-------------

429-4000	U-Bend 1 1/2"Sx 1 1/2" S
----------	--------------------------



PART NUMBER	DESCRIPTION
-------------	-------------

510-4669LC-DSG	TELEWEIR 50SF 2CKV 6SCP NO INSERT
----------------	-----------------------------------



PART NUMBER	DESCRIPTION
-------------	-------------

550-7767	Skimmer filter
----------	----------------



519-0137	BRACKET-HINGE WEIR CUSTOM
----------	---------------------------

819-4350	SCREW, #8X5/8 PPH- CS VLV,LTBX,VLV MTR, for split nut 400-5421
----------	--

PART NUMBER	DESCRIPTION
-------------	-------------

400-9050	Cartridge Mounting Assembly 1 1/2" S -90 deg. Ell body
----------	--



711-3150	1 1/2" grommet gasket
----------	-----------------------

PART NUMBER	DESCRIPTION
-------------	-------------

PWW50L	50 sq. Ft. Filter Cartridge with Handle on top and 1.5" female SAE thread on bottom, approx. 127x330mm
--------	--



PART NUMBER	DESCRIPTION
-------------	-------------

PRB50IN	Filter Cartridge 3oz 127x338mm, hole 54mm top and bottom Fits: 636 Sunspot, 749 Prism >2006, 791 Eclipse >2005 PRB 25-IN, Filbur FC 4375 - FC 2375.
---------	---



## Filter Systems & Filters

### PART NUMBER DESCRIPTION

PRB25IN Filter Cartridge 127x338mm, hole 54mm top and bottom  
Fits: 636 Sunspot, 749 Prism >2006, 791 Eclipse >2005  
PRB 25-IN, Filbur FC 4375 - FC 2375.



01.05.01.0309 Filter Cartridge SF25 127x338mm, hole 54mm top and bottom

### PART NUMBER DESCRIPTION

PSN25P Filter Cartridge for spa 152 x152 mm (2 filters per spa)  
Fits: 799 Galileo (2004 - Present) 780 Odyssey (2005 - Present)Etc



### PART NUMBER DESCRIPTION

PPG50P4 Filter Cartridge 15.2 cm diameter x 20.3 cm length  
Fits: 680 Little Dipper, 770 Journey, 849 Zodiac, All Paragon models 899 Poseidon, 939 Endeavour, 949 Meridian, 989 Aquarian 959 Equinox, 860 Gemini (2003), 2000 Millennium (1999 - 2001) [European thread 38mm](#)



### PART NUMBER DESCRIPTION

PRB17,5SF Filter Cartridge 1 pair (2 pcs.) 817-3510 127x117mm, [top hole 54mm](#).[bottom hole 56mm](#)  
2 filters required per spa Fits: 550 Hydra, 590 Sunquest (2000 and older) 727 Horizon, filter set for front load filters



### PART NUMBER DESCRIPTION

PWW10 Filter Cartridge 817-0010 Fits Sunquest ( 2001-2003) [108x102mm](#), hole 51mm top and bottom  
Waterway Plastics Replacement Part Numbers: 817-0010, 8170010



### PART NUMBER DESCRIPTION

PDM25P4 Filter Cartridge 121 x 206 mm handle on the Top,  
Bottom hole: [38 mm](#), mit P4 Adapter Fits: Cottager, Garden Mate, X-Spa-dition, X-Calibur, EZSPA, X400, X500, Fantasy  
Filbur FC-0136, Unicel 4CH-21, Roto spas



### PART NUMBER DESCRIPTION

PSN50L-P Filter Cartridge 178x[357mm](#), bottom 48mm (with 1 1/2" MPT Adaptor), Handle on top, f.e. for Sunrise Spa Fits: 680 Little Dipper (2000), 799 Galileo (1999 - 2003) 780 Odyssey (2000 - 2003) Euro Thread





## Filter Systems & Filters



PART NUMBER	DESCRIPTION	
PSN50SV-P	Filter Cartridge 178 x 152 mm Top: Handle Bottom: PAD Adapter 2 filters required per spa , Fits: 860 Gemini (2003 \< May 1)	

PART NUMBER	DESCRIPTION	
PWW50P3	Filter Cartridge with adapter for American Thread 817-0050 6" (15.2cm) diameter x 8 1/4" (21cm) length comes with PAD adapter 2 filters required per spa/solid 'D' handle Suits Waterway skimmer weir filters, Signature Spas, Spaquip filters Used on most current spas in Australia since approx 2000, including: Maax, Lanark, Heritage, Palm Springs, Signature, Cyclone, Designer series, Endless, Stylus, Timeless, Sapphire, and others.	

PART NUMBER	DESCRIPTION	
PSD125U	Sundance filter, diam. 216mm, length 451mm, bottom hole 64mm Filbur Filbur FC-2790, Unicel C-8325	
PSD125-2000	Sundance filter diam. 216mm, length 483mm, top hole slip 56mm bottom hole 70mm, Sundance double end 120, Unicel C- 8326, Filbur FC-2780	

PART NUMBER	DESCRIPTION	
PRB-35IN	127x235mm, hole 54mm top and bottom Eclipse, wave, crest, celeste, Replacement Cartridge for Dynamic Series IV - DFM, DFML, Waterway 35, In-Line,	
PWW35P3	Filter Cartridge length 194mm diameter 152mm USA thread Replaces: Filbur, Unicel	

## Filter Systems & Filters







PART NUMBER	DESCRIPTION	
01.03.03.0229	Filter cartridge - 25 sq ft	
PART NUMBER	DESCRIPTION	
01.03.03.0100	<p>Filter cartridge for Front access skimmer</p> <p>Length = 294mm, Diameter 215mm, Internal USA Thread M65*20</p>	
PART NUMBER	DESCRIPTION	
01.03.03.0101	<p>Filter cartridge- 50 sq ft (US thread) - for 100 sq ft filter</p> <p>Length = 210mm, Diameter 150mm, Internal USA Thread M45*20</p> <p>Fits for all swim spas and OS400, OS500, PS100, PS200, PS300, PS400, PS500, PS600.</p>	
01.03.03.0412	Filter Cartridge - 50 sq ft (EU Thread)	
PART NUMBER	DESCRIPTION	
01.03.03.0106	<p>Filter cartridge-75SF/345mm (with handle top) - for Rising Dragon handle top - Non Silver</p> <p>Length = 350mm, Diameter 120mm, Internal USA Thread M50*10</p> <p>Fits for DS100/ DS200/ DS300/ DS400/ OS100/ /S200/ /S300.</p>	



## Tubing

PART NUMBER	DESCRIPTION	
110-0120PB	3/8" x 9/16" Clear Vinyl Tubing 150 meter rolls price per meter	
110-0140PB	3/4" Clear Vinyl Tubing 45 meter rolls price per meter	
110-0110	1/4" x 3/8" Clear Vinyl Tubing 180 meter rolls price per meter	
PART NUMBER	DESCRIPTION	
120-0120PB	3/4" SPA FLEX white 30meter rolls price per meter	
120-0110PB	1/2" SPA FLEX white 30meter rolls price per meter	
120-0130PB	1" SPA FLEX white 15meter rolls price per meter	
120-0140PB	1 1/2" SPA FLEX white 15meter rolls price per meter	
120-0150PB	2" SPA FLEX white 15meter rolls price per meter	
120-0150-40BX	2" SPA FLEX white straight lenght per meter	
01.03.03.0028	1.5" PVC pipe - (30m/Roll) price per meter	
01.03.03.0029	2" PVC pipe - (30m/Roll) price per meter	
PART NUMBER	DESCRIPTION	
01.03.03.0031	1"PVC Pipe - P005-025 price per meter	
01.03.03.0032	1.5"PVC Pipe - P005-40 price per meter	
01.03.03.0033	2" PVC Pipe - price per meter	
PART NUMBER	DESCRIPTION	
01.03.03.0034	3/4" PVC pipe - NSF61 price per meter	
01.03.03.0035	3/8" PVC pipe - NSF61 price per meter	

## Manifolds

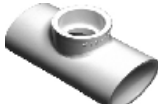
PART NUMBER	DESCRIPTION	
672-7100	3/4" Barb manifolds 2" S x 2" S x (2) 3/4" RB	
672-7110	3/4" Barb manifolds 2" S x 2" S x (4) 3/4" RB	
672-7120	3/4" Barb manifolds 2" S x 2" S, (6) 3/4" RB	
672-7130	3/4" Barb manifolds 2" S x 2" Spg x (2) 3/4" RB	
672-7140	3/4" Barb manifolds 2" S x 2" Spg, 3/4" RB	
672-7150	3/4" Barb manifolds 2" S x 2" Spg, 3/4" RB	
PART NUMBER	DESCRIPTION	
672-7170	2" S x Dead End, 3/4" RB	
672-7180	3/4" Barb manifolds 2" S x Dead End x(6) 3/4" RB	
PART NUMBER	DESCRIPTION	
672-8020	Manifold Wye 1"S x 3/4"S x 3/4"S	
672-4570	Manifold 1 1/2"S x (4) 1/2" S Ports	
PART NUMBER	DESCRIPTION	
672-4430	Manifold 2"S x 2"S x (4) 1/2"S Ports	
672-4110	1/2" manifolds 2" S x 2" S x 1/2"S Ports	
672-4210	3/4" manifolds 2" Spg x 2" x (4) 3/4" S Ports	
672-4270	3/4" manifolds 2" S x 2" S x 3/4" , 6 Plugs	
672-4250	1/2" manifolds 2" Spg x 2" x (4) 1/2" S Ports	
PART NUMBER	DESCRIPTION	
421-1050	Reducer 1" Spg x 1/2" S	
421-4070	Reducer Adapter 2" -1 1/2"	
PART NUMBER	DESCRIPTION	
413-2030	Tee, 1" S x 1" S x 1 1/2" S	

## Fittings

PART NUMBER	DESCRIPTION	
413-2150	Tee, 2" Spg x 2" S x 1/2" S	
PART NUMBER	DESCRIPTION	
413-4350	Barb Adapter Fitting 1"S x 1"S x 3/8" RB T-Bod	
413-1850	3/4" Barb Adapter 3/4" SB x 3/4" SB x 3/8" SB Tee	
PART NUMBER	DESCRIPTION	
411-2020	45° Street Ell 1" S x 1" Spg	
411-4040	45° Street Ell 1 1/2" x 1 1/2"	
411-5030	45° Street Ell 2" x 2" SPG	
PART NUMBER	DESCRIPTION	
01.03.03.0148	<a href="#">1" 90 Degree ell (Soc x Soc)-#Z901-025025</a>	
01.03.03.0149	<a href="#">1.5" Soc x Spig 90° elbow-#204204</a>	
<a href="#">01.03.03.0152</a>	<a href="#">1.5" Soc x Spig 45° elbow- #204204</a>	
411-4080	90° Street Ell 1 1/2" x 1 1/2" x 1/2"S Takeoff	
PART NUMBER	DESCRIPTION	
417-6127	Metric adapter 1" Spg x 32mm S Metric	
417-6137	Metric adapter 1 1/2" Spg x 50mm S Metric	
417-6197	Adapter 2" Spg x 63mm S Metric	
PART NUMBER	DESCRIPTION	
419-4000	Coupling 1 1/2" S x 1 1/2" S	
PART NUMBER	DESCRIPTION	
419-1000	3/8" barbed coupling	
419-0900	3/4" barbed coupling	

## Fittings

PART NUMBER	DESCRIPTION
715-0000	1/2" Spigot, Plug for socket fitting
715-9890	3/4" Spigot, Plug for socket fitting
715-2000	1" Spigot, Plug for socket fitting
715-4000	1 1/2" Spigot plug for socket fitting
715-9880	2" Spigot plug for socket fitting



PART NUMBER	DESCRIPTION
715-9870	3/8" , Plug for socket fitting
715-0040	Plug 3/4" for socket fitting



PART NUMBER	DESCRIPTION
425-0210	3/8" Barb special fitting 1/2" Spg x 3/8" RB
425-1030	3/4" Barb adapter 1/2" S-3/4" Spg x 3/4" RB/20mm
672-4310	3/4" Barb adapters 1" Spg/3/4" S x 3/4" RB
413-4360	BARB ADAPTER 1 1/2" Spg x 3/4" SB
425-1000	3/4" Barb special fitting 1/2" Spg x 3/8" RB
413-4520	BARB ADAPTER 2" x 3/4"RB
01.03.03.0173	<a href="#">3/4" Barbed Adapter - 715 700</a>
50100120	Threaded adapter 1 1/2" x 2" can be used for circ. Pumps



PART NUMBER	DESCRIPTION
01.03.03.0151	1.5" 90 Degree ell Soc x Soc - 228204
01.03.03.0154	2" 45 Degree ell Soc x Soc - 220204



PART NUMBER	DESCRIPTION
01.03.03.0211	2" 90 Degree ell Soc x Soc - 210204



PART NUMBER	DESCRIPTION
01.03.03.0159	1" Tee - A0A15T001025025
01.03.03.0160	1.5" Tee - A0A15T001040040
01.03.03.0161	2" Tee - A0A15T001050050



## Fittings

PART NUMBER	DESCRIPTION	
01.03.03.0162	2" Y Type Tee #21007-000-000	
PART NUMBER	DESCRIPTION	
01.03.03.0165	2"×2"×3/4" Tee - A0A15T002050020	
PART NUMBER	DESCRIPTION	
01.05.01.0334	1/2" Coupling	
01.03.03.0394	3/4" Coupling #20020	
01.03.03.0166	1" Coupling	
01.03.03.0167	1.5" Coupling #A0A15S001040040	
01.03.03.0168	2" Coupling #A0A15S001050050	
PART NUMBER	DESCRIPTION	
01.03.03.0172	3/4" Plug - 3/4"	
PART NUMBER	DESCRIPTION	
01.03.03.0169	1"S x 3/4"SB Reducer, adapter RD601-2015	
01.03.03.0179	1.5"×1" Reducer , adapter A0A15S002040025	
01.03.03.0180	2"×1.5" Reducer , adapter A0A15S002050040	
01.03.03.0181	2"× 1.5" Reducer - 120-105	
PART NUMBER	DESCRIPTION	
01.03.03.0189	1.5" Union	
PART NUMBER	DESCRIPTION	
01.03.03.0147	1" 90 Degree ell Spig x Soc - 126610	
PART NUMBER	DESCRIPTION	
413-4160	Wye 120° - 1"S x 1"S x 1"S	
413-5080	Wye120° Wye, 2" S x 2" S x 2" S	
413-1860	3/4" Ribbed Barb Wye	

## Fittings

PART NUMBER	DESCRIPTION	
212-1807	Air Bleed 3/8"SB	
805-0111	O-Ring Drain Plug	
PART NUMBER	DESCRIPTION	
711-2070	1" AIR CONTROL GROMMET GASKET OPAQUE	
PART NUMBER	DESCRIPTION	
411-9100	Sweep ell 1 1/2" Spg x 1 1/2" Socket	
411-9130	Sweep ell 2" Socket x 2" Socket	
411-9120	Sweep ell 2" Spg x 2" Socket	
PART NUMBER	DESCRIPTION	
400-5800	specialty Pump union 2" Union Nut with 2" Spg 90° Tailpiece and O-Ring	
PART NUMBER	DESCRIPTION	
640-4229-DSG	Low Profile Return Fitting 3/4" SB 90°	
640-4149G-DSG	LO-PRO 1 1/2" ELL BODY RETURN FITTING ASSY	
640-4227	Low Profile Return Fitting 3/4" SB 90° grey	
640-4127	LO-PRO 1 1/2"SB STRAIGHT RETURN FITTING	
PART NUMBER	DESCRIPTION	
212-1827	Bulkhead Wall Fitting Assembly 3/4" Ribbed Barb	
PART NUMBER	DESCRIPTION	
417-5180	2" x 3/4"S / 1" Spg Heater Union Tailpiece	
417-5160	TAILPIECE, 1 1/2"S X 2" SPG BUTTRESS NO HEX	
417-5050	2" Heater Union Tailpiece	
711-4030	2" Heater tailpiece O-ring gasket	

**Fittings**

**Lighting**

PART NUMBER	DESCRIPTION	
400-5421	2" Heater split nut with screws	
400-5491	1.5" Heater split nut with screws	
86-02336B	Uni-Nut Retainer ring 2"	
PART NUMBER	DESCRIPTION	
670-2009-DSG	WATER NOZZLE WALL FITTING ASSEMBLY	
PART NUMBER	DESCRIPTION	
805-0111	O-Ring Drain Plug	
715-1201	3/8" Drain plug	
PART NUMBER	DESCRIPTION	
413-1201	Adapter 3/8" B x 1/4" N.P.S.M Air bleed fitting	
01.05.01.0331	Air Bleed fitting for LX pumps	
PART NUMBER	DESCRIPTION	
630-5008	LED Light 3,5" SPA Light	
813-4370	SPA LIGHT BULB	
PART NUMBER	DESCRIPTION	
630-K008	5" / 127mm Spa Light, Designed to accept LED Multi-Function Lamp.	
PART NUMBER	DESCRIPTION	
633-7078	Threaded Facet Light w/LED Sleeve 1/2"	
633-7098	Threaded Facet Light w/LED Sleeve clear, multi-faceted body light	

## Lighting

PART NUMBER	DESCRIPTION	
01.05.02.0020	Mini-LED Light componenent	
01.03.03.0066	MINI-LED light cover-MINIE-00000	
01.03.03.0067	MINI-LED nut-MINIE-00001	
01.03.03.0068	MINI-LED seal-MINIE-00003	

PART NUMBER	DESCRIPTION	
701739-SA	Ultra Bright 12 LED Light with Standoff	

PART NUMBER	DESCRIPTION	
701678-DLO	Led lighting control box Control 40, "Daisy Link"	





PART NUMBER	DESCRIPTION	
701564-1-DLO	Single LED RGB Daisy Chain Assy	
701564-2-DLO	Dual RGB LED Daisy Chain Assy	
701564-4-DLO-XL	Quad RGB LED Daisy Chain Assy long wires Wire: 193 cm / 96 cm / 61 cm	

PART NUMBER	DESCRIPTION	
9920-101436	ASSEMBLY CABLE KIT IN.LINK 240V Includes: cables for high current 2 speeds 240V, high current 1 speed 240V, low current 240V, low current 120V, light and keys for P1, P2, BL, OZ	
95100439	Cord/Cable mini molded TUV w/o RST 2Speed pumps 14/4 I	
600DB0967	Cable In.Link HC 2S 15A 240V 8Ft. T CE	

PART NUMBER	DESCRIPTION	
701570-14-DLSO	14 LED, 3" Light Daisy Chain + Standoff	
701570-21-DLSO	21 LED, 5" Light, Daisy Chain	
410117-60	5' Daisy Chain Jumper ca. 1,7m	



## Lighting

PART NUMBER	DESCRIPTION	
01.03.05.0057	40(1m)MINI Main Lighting Wire - MINI0-00010	
PART NUMBER	DESCRIPTION	
01.03.03.0107	5" Light Housing - Complete Set - RD631-1040	
01.03.03.0108	5" Light Housing - Complete Set - Without Holder/RD631-1040	
PART NUMBER	DESCRIPTION	
01.03.05.0058	LED Light String	
01.03.05.0059	0.75m MINI Lights Unit 2 - for LED Light String MINI0-Q1Y32 Input DC5V	
01.03.05.0060	0.75m MINI Lights Unit 3 - for LED Light String	
01.03.05.0061	0.75m MINI Lights Unit 4 - for LED Light String MINI0-Q1Y34 Input DC5V	
01.05.01.0325	<a href="#">LED Double Mini/MINI0-RD0Z2(2 Units)</a>	
PART NUMBER	DESCRIPTION	
01.03.05.0066	L-60A Main Lighting - L60A0-00ATL	
PART NUMBER	DESCRIPTION	
01.03.05.0067	L-60C Spa Main Light 3m Cable Positive LED, VH-2P Terminal)	
01.03.06.0041	Pin for AMP plug	
01.03.03.0036	<a href="#">AMP Plug (4 holes)</a>	
PART NUMBER	DESCRIPTION	
01.03.05.0163	<a href="#">5" Under Water Light (In.Link) Terminal</a>	
PART NUMBER	DESCRIPTION	
01.03.05.0068	4 Lines Waterproof 5"Light L15SF-GOATL (1.5m Input Wire, With Waterproof Plug, Positive LED)	
01.03.05.0062	K100A Power adapter for LED light GFP241DA-0540	

## Pumps & Parts

PART NUMBER	DESCRIPTION
-------------	-------------

3312620-14EU	TINY MIGHT CIRCULATING PUMP with 230V 50Hz IPX5 CE Motor
--------------	--



PART NUMBER	DESCRIPTION
-------------	-------------

PF202N22X	E.M.G. 4HP pump 2", with 230V /50Hz two speed Motor MEC90 1,5kW IPX5/CE, RETURN TO THE TOP
-----------	--



PART NUMBER	DESCRIPTION
-------------	-------------

672-1320	Pump Base EMG (pair)
----------	----------------------



PART NUMBER	DESCRIPTION
-------------	-------------

310-1160SD	2" HI FLO SIDE DISCHARGE wet end 48 Frame, 4HP
------------	--



PART NUMBER	DESCRIPTION
-------------	-------------

01.03.05.0006	2HP Single Speed Pump 220-240V/50HZ/LP200 2.8m power line,AMP terminal,shrink tube
---------------	---

01.03.05.0176	<a href="#">2HP Pump 220-240V/50Hz/LP200 (2.4m In.link cable)</a>
---------------	---

01.03.05.0007	<a href="#">2HP Pump 220-240V/50Hz/LP200 (8m power cable,AMP terminal,shrink tube)</a>
---------------	--

01.03.05.0012	2.5HP Single Sp Pump 220/240V/50HZ/LP250/ 1.85KW
---------------	--

01.03.05.0016	3HP Single Speed Pump 220-240V/50HZ/LP300 (2.8m power line,AMP terminal,shrink tube)
---------------	---

01.03.05.0245	3HP Single Speed Pump 220-240V/50HZ/LP300 (2.4m Wire In.Link)
---------------	---

01.03.05.0017	<a href="#">3HP Single Speed Pump 220-240V/50HZ/LP300 (8m power cable,AMP terminal,shrink tube)</a>
---------------	---

01.03.05.0018	<a href="#">3HP Single Speed Pump 240V/50HZ/LP300 (2.8m power cable,AMP terminal,shrink tube)</a>
---------------	---



PART NUMBER	DESCRIPTION
-------------	-------------





01.03.05.0025	2HP 2 Speed pump 240V/50HZ/WP200/APM terminal 2.8m
---------------	--

01.03.05.0029	3HP Two Speed Pump 220-240V/50HZ/WP300-II (2.8m power line,AMP terminal,shrink tube)
---------------	---

01.03.05.0174	<a href="#">3HP Two Speed Pump220-240V/50HZ/WP300- II (2.4m power cable)</a>
---------------	--











## Pumps & Parts

PART NUMBER	DESCRIPTION	
01.03.05.0001	0.5HP Circulation Pump 220-240V/50HZ/JA50 (2.8m wire,0.35HP impeller,AMP terminal,shrink tube)	
01.03.05.0249	0.5HP Circulation Pump 220-240V/50HZ/JA50 (2.4m In.link cable)	
01.03.05.0003	0.5HP Circulation Pump (upgraded) 220-240V/60HZ/JA50 (2.8m power cable,0.35HP impeller,AMP terminal,shrink tube)	
01.03.05.0244	1HP Circulation Pump 220-240V/50HZ/JA100 (2.4m Wire In.Link)	
01.03.05.0092	1HP Circulation Pump 220-240V/50HZ/JA100 (3m power cable,AMP terminal,shrink tube)	
PART NUMBER	DESCRIPTION	
01.03.05.0265	TDA50 Circ. pump 220-240V/50HZ 0.37KW	
01.03.05.0266	TDA75 Circ. Pump 0.55KW	
PART NUMBER	DESCRIPTION	
06120916-2040	2-speed pump XP2-2SPD-2HP-No Cable 06120914-1300	
07030010-2040	1 speed pump XP2-1SPD-2HP-No Cable 07030009-6300	
PART NUMBER	DESCRIPTION	
01.05.01.0155	Pump seal	
01.05.01.0336	M5*16 hexagon screw (for 3P Pump Cover)	
01.05.01.0337	M5*18 corss head screw (for 3P Pump Cover)	
PART NUMBER	DESCRIPTION	
52272000	2" Union Nut, O-ring and Tailpiece G 400-5570	
96.03.0046	2" Union Nut, O-ring and Tailpiece for LX pumps	
52271000	1 1/2" Union Nut, O-ring and Tailpiece	
98.01.0710	1 1/2" Union Nut, O-ring and Tailpiece for LX pumps	
PART NUMBER	DESCRIPTION	
Laing	Laing circ Pump Magnetic drive low flow circulation pump 220-240V 9-63watts 50/60Hz	
Laing-E14	Max.Capacities 36GPM, Max. Head 9' 230V 0.43AMP 98Watts 50/60HZ 2100 RPM 1/2"Buttress Threads Suctions	

## Pumps & Parts









PART NUMBER	DESCRIPTION	
02920000-2020	PUMP Circ.Master CP R0 1/15HP CONT. 220V 50HZ 1SPD (0.75 Kw)	
PART NUMBER	DESCRIPTION	
91693551	IMPELLER 3/4 HP STANDARD FLO Part for Flo-Master HP/CP and Circ-Master HP/CP pumps	
91694200	XP2 IMPELLER 2 HP	
PART NUMBER	DESCRIPTION	
92500150	SEAL REPLACEMENT Part for XP2e, XP2, XP3 and Flo-Master HP/CP pumps	
PART NUMBER	DESCRIPTION	
91040810-000	WET END, FloMaster CircPumps, 1.0 HP, 1.5"	
310-1720	2"Executive intake Wet end 56 Frame, 2 HP Waterway	
310-1740	2"Executive intake Wet end 56 Frame, 4 HP op wet end 317-1740 Waterway	
01.05.02.0023	<a href="#">wet end kit - for 3HP LX single speed pump</a>	
PART NUMBER	DESCRIPTION	
92200120	O-RING FOR DRAIN PLUG Part for Flo-Master HP/CP and Circ-Master HP/CP pumps	
PART NUMBER	DESCRIPTION	
319-3100B	Pump Seal Set	
PART NUMBER	DESCRIPTION	
550-9107	Custom Weir Door Assembly	
550-2637	Weir assembly	
519-8057	Scallop trim ring high volume	
500-2687	Basket	
01.05.02.0019	<a href="#">Twin Cilinder Skimmer Front Cover Assembly kit</a>	

**Options, Steps, Handrail**







PART NUMBER	DESCRIPTION	
01.03.03.0075	Swimming Training product	
PART NUMBER	DESCRIPTION	
01.03.03.0121	2 Loose Joint(assembly)-Transparent-RD411-1120	
PART NUMBER	DESCRIPTION	
01.03.03.0122	2 Soc*3/4Spg Adaptor-Clear-RD411-0429	
PART NUMBER	DESCRIPTION	
01.02.12.0004	Stainless steel Handrail kit- (φ28*600mm) Old Part# 01.03.06.0054	
01.02.12.0005	Stainless steel Handrail kit- (φ28*400mm) Old Part# 01.03.06.0055	
PART NUMBER	DESCRIPTION	
01.05.02.0009	Towel Bar assembly kit	
01.05.01.0398	Spa-Vac vacuumcleaner	
PART NUMBER	DESCRIPTION	
01.04.02.0004	Cover Lifter - Simplicity - Rising Dragon - RD801-9800	
01.05.01.0317	Cover lock	
PART NUMBER	DESCRIPTION	
01.04.03.0023	Safety Handrail Old part# 01.03.06.0057	

## Options, Steps, Handrail

### Ozonators & Parts

PART NUMBER	DESCRIPTION	
535-2209-GPH	Spa wall step assembly Graphite	
535-2209-BRK	Spa wall step assembly Brown	
PART NUMBER	DESCRIPTION	
01.04.02.0033	2 tier step grey Old part # 01.04.0.00003	
PART NUMBER	DESCRIPTION	
01.04.03.0008	3 tier step grey ONLY ON SPECIAL ORDER	
01.04.03.0010-5	4 tier step L600/H800/W1140mm Dark Grey	
PART NUMBER	DESCRIPTION	
01.05.02.0017	Ozone mixing chamber Assembly kit Extends the life of your cover, easy to install	
PART NUMBER	DESCRIPTION	
01.03.03.0126	Venturi - 23006000000	
PART NUMBER	DESCRIPTION	
01.03.03.0129	Ozone Injector - Carbon Grey - 23400107000	
PART NUMBER	DESCRIPTION	
01.03.03.0221	Ozone Connection (whole set) - External Pearl Grey/RD641-1090	
PART NUMBER	DESCRIPTION	
01.03.03.0258	4 way Manifold 2" Soc×Plug×3/4" Spg-0365-20	

### Ozonators & Parts

PART NUMBER	DESCRIPTION	
01.03.05.0034	Ozone Generator 220-240V/50-60HZ/50-80mh/7W	
PART NUMBER	DESCRIPTION	
01.03.05.0035	CP Ozone Generator 220-240V/50Hz/ (with AMP Terminal and Plug)	
01.03.05.0246	CP Ozone Generator 220-240V/50Hz/ (with 2.4m GECKO Wire)	
PART NUMBER	DESCRIPTION	
598-D	Corona discharge ozonator Aqua Sun with in.link cord XL-80	
598-B	Corona discharge ozonator Aqua Sun with jj. Mini cord XL-80	
744-A	Corona discharge ozonator Aqua Sun with AMP Connector XL-80	
PART NUMBER	DESCRIPTION	
596-A	Corona discharge ozonator Aqua Sun with AMP connector XL-60	
596-B	Corona discharge ozonator Aqua Sun with jj.mini cord XL-60	
596-D	Corona discharge ozonator Aqua Sun with in.link cord XL60	
PART NUMBER	DESCRIPTION	
01.03.03.0114	CP Ozone Check Valve	
01.03.03.0298	DG Ozone check valve	

**Electronics & Packs**

PART NUMBER	DESCRIPTION
-------------	-------------

01.03.05.0193	C-II PCB (new model)
---------------	----------------------



01.05.01.0223	C-II PCB (new model) Extension Board
---------------	--------------------------------------



PART NUMBER	DESCRIPTION
-------------	-------------

01.03.05.0192	C-II PCB (old model)
---------------	----------------------



PART NUMBER	DESCRIPTION
-------------	-------------

96.03.0099	C-I Circuit Board
------------	-------------------



PART NUMBER	DESCRIPTION
-------------	-------------

01.03.05.0200	MP10 Standard Control Panel (silver)
---------------	--------------------------------------



PART NUMBER	DESCRIPTION
-------------	-------------

01.03.05.0051	BALBOA Control Box and 3KW Heater GS510SZ -2 pumps + 1 Blower or 3 pumps
---------------	---



PART NUMBER	DESCRIPTION
-------------	-------------

01.03.05.0049	BALBOA Control Box and 3KW Heater GS501Z 1 pump +1 blower or 2 pumps
---------------	---



01.05.01.0310	0.5HP Circ. Pump Cable, with AMP Terminal, 2.8Meter
---------------	---

01.05.01.0201	Blower Cable with AMP terminal, 2.8 meter
---------------	---

PART NUMBER	DESCRIPTION
-------------	-------------

01.03.05.0148	BALBOA Control Box with 3KW Heater GS523 Fit for 3 pump spa
---------------	--



53860-04	BALBOA Board GL8000 M3
----------	------------------------

55857-01	BALBOA Board GS523GZ
----------	----------------------



**Electronics & Packs**

PART NUMBER	DESCRIPTION
-------------	-------------

01.03.05.0181	BALBOA Control Box with 3KW Heater GL8000 Fits for 4 pump spa Old part# 01.03.05.0056
---------------	--



PART NUMBER	DESCRIPTION
-------------	-------------

01.03.05.0054	AX40 Balboa top panel
01.03.05.0053	Extended wire for the AX40 control panel
11823	Overlay Balboa AX40 control panel



PART NUMBER	DESCRIPTION
-------------	-------------

11822	Overlay Balboa VL400 control pane
-------	-----------------------------------

PART NUMBER	DESCRIPTION
-------------	-------------

01.03.05.0055	ML700 Balboa GL8000 top panel
11281	Overlay Balboa ML700 control panel



PART NUMBER	DESCRIPTION
-------------	-------------

01.03.05.0149	VL801D Control panel Balboa fits Pack GS523GZ
10763	Overlay Balboa VL801D SLDX2J/BLO



PART NUMBER	DESCRIPTION
-------------	-------------

01.03.05.0050	VL700 Balboa GS510 top panel
11688	Overlay Balboa VL700 control panel



PART NUMBER	DESCRIPTION
-------------	-------------

01.05.01.0210	Balboa fuse 3A
01.05.01.0211	Balboa fuse 10A
01.05.01.0208	Balboa fuse 30A

PART NUMBER	DESCRIPTION
-------------	-------------

01.03.05.0201	MP20 Standard Control Panel blue
---------------	----------------------------------



01.03.05.0207	AP20 Control Pannel blue
---------------	--------------------------



PART NUMBER	DESCRIPTION
-------------	-------------

01.03.05.0206	AP10 Control Panel silver
---------------	---------------------------



**Electronics & Packs**

PART NUMBER	DESCRIPTION
-------------	-------------

01.03.05.0208	DP10 Control Panel silver
---------------	---------------------------



PART NUMBER	DESCRIPTION
-------------	-------------

01.03.05.0209	DP20 Control Panel blue
---------------	-------------------------



PART NUMBER	DESCRIPTION
-------------	-------------

01.03.03.0112	Spa Stereo CD Box - 25268-004-000
---------------	-----------------------------------



[01.05.01.0192](#)     [Audio Cable\(3m\)](#)

PART NUMBER	DESCRIPTION
-------------	-------------

01.03.05.0182	New Car DVD DEH-4050 (with AUX Terminal) <b>Old part# 01.03.05.0076</b>
---------------	--



PART NUMBER	DESCRIPTION
-------------	-------------

01.03.05.0077	JVC KD-R508 CD with Radio
---------------	---------------------------



**Electronics & Packs**

PART NUMBER	DESCRIPTION
66.11.11.0011	I-Pod dock, subwoofer, and 2 x Aquatic speakers - Including below 3 part#
01.02.06.0082	Ipod holder kit <b>Old part # 01.03.03.0113</b>
01.02.06.0087	Subwoofer Kit Complete
01.03.05.0165	AQ-SPK-3.0 Speaker



PART NUMBER	DESCRIPTION
66.11.11.0012	I-Pod dock, subwoofer, waterproof remote control, and 2 x Aquatic speakers



PART NUMBER	DESCRIPTION
66.22.11.0022	Movable TV 17" waterproof, DVD player & subwoofer - Including below 3 part#
01.04.03.0022	Movable waterproof TV standard version (3 parts)
01.02.06.0079	Car DVD Kit
01.02.06.0087	Subwoofer Kit Complete



PART NUMBER	DESCRIPTION
01.03.05.0320	Power pack for subwoofer 230V 50HZ, output DC12V, 8A Old part# : 01.03.05.0169
01.02.06.0155	Power switch system for subwoofer Incl. Power button
01.03.05.0274	Power Button for subwoofer (silver color)
01.03.05.0273	Sub-woofer power switch box





PART NUMBER	DESCRIPTION
01.03.05.0075	6inch Subwoofer DC12V/10A
01.02.06.0087	Subwoofer Kit Complete
01.03.05.0165	AQ-SPK-3.0 Speaker
01.03.05.0074	Round Spa Pop-up Speaker- 77701-000-000







**Electronics & Packs**

PART NUMBER	DESCRIPTION	
0202-201023	Spa builders S class electronic pack SC-MP-P12-P21-CP-O-H2.0-LS-JJM-CE-GE1 Jet one always dual speed; Blower will have its own key; If one pump and a blower, will have to change the overlay for 9916-100427; If a 2 pumps system, will need to change the overlay for 9916-100219; No purge cycle only filtration cycle; No more low-level programming only jumpers; No FIL, AFP or PUR display anymore 0202-201015	

PART NUMBER	DESCRIPTION	
0201-209029	MSPA PACK NEWEST EDITION MC-MP-P122-P222-P312-B2-02-CP-2-NE-A12-A22-LS-H3.6-RTC WLSC-IR-JJM-CE-GE2	
0201-300046	BOARD Replacement package ASSY KIT MC-MP-CE-GE Can be used for all MSPA packs No Pur, Fil, Afp display; No dual set point mode; Can only control a fiber optic or a regular light, not both at the same time	

PART NUMBER	DESCRIPTION	
0602-221002	in.Xe ce spa Pack 230V 50Hz in.link light harness sold separately 2Kw, 5 output 0602-221023 IN.XE-5-11-H4.0-1-2-C-O-D-32K-CE-GE1	
01.03.05.0110	IN.XE ce spa Pack 230V 50Hz in.link light harness sold separately 2Kw, 5 output 0602-221023	

PART NUMBER	DESCRIPTION	
0601-221028	in.Xm ce spa Pack 230V, 50Hz in.link light harness sold separately IN.XM2-CE generic + Prog IN.XM1-8-3-2-1-K-B-K-O-D-R-CE-GE1	
01.03.05.0108	<a href="#">Gecko control Box - IN.XM(220-240V/50HZ) / GECKO-0601-221048</a>	

PART NUMBER	DESCRIPTION	
0603-421001	in.therm remote Heater 3.8Kw 50Hz CE IN.THERM-H3.8-CE	
0603-421003	in.therm remote Heater 2.0 Kw 50Hz CE IN.THERM-H2.0-CE	



**Electronics & Packs**

PART NUMBER	DESCRIPTION
25-4026ET-BI	Heater element 2KW 240V for Balboa M-7 Dual sensor heater
25-4036ET-BI	Heater element 3KW 240V for Balboa M-7 Dual sensor heater
70-20620-TE	2 KW 240V Heater element
70-20630-TE	3 KW 240V Heater element
70-20650-TE	5 KW 240V Heater element

Can be used for: Gecko, Hydro Quip, ACC, Sundance, Spa Builders Support Group (SBSG), Brett, Cal Spas, Consumer Engineering/Vita Spas. Acura, Coates, Coleman, United Spa packs, Spa Components, Watkins/Hot Springs, Nuwave, Marquis, Coast Spas, Newport Controls, Leisure Bay, Gatsby, and older Balboa heaters.

PART NUMBER	DESCRIPTION
560aa0430	transformer SC-CF / MP XFO 240/0/12/21.5VAC 30VA WIRE
9920-100225	transformer MSPA-MP-CE ASSY TRANSFO & CONN 240V CET
01.03.05.0081	Transformer (Spa-tech)- IN: 220V, 50HZ, OUT: 11V, 1A; 11V, 2A EI-66A2



PART NUMBER	DESCRIPTION
510ad0167	Pressure switch DTECH" version - 2.0PS SL 20MA 5V 2.0PSI
9920-400124	Pressure switch cable MC-MP CABLE FLOW SWITCH 18 IN



PART NUMBER	DESCRIPTION
9920-400342	temperature Probe - 10' (3m) SC-CF-CE & MC-MP-CE CABLE+PROBE TEMP THERMISTOR SSPA CE



PART NUMBER	DESCRIPTION
9920-400178	CABLE + SOCKET DE LAMPE 8 FT light wire Harness for #912 incandescent or 12V digital LED bulb SC-CF-CE
9920-400604	CABLE LIGHT SOCKET 8 FT CE MTA 3 PIN Light wire harness for #912 or 12V digital LED bulb MC-MP-CE
9920-401022	CABLE IN.LINK LIGHT-LV 12FT Light wire harness

PART NUMBER	DESCRIPTION
9920-100317	HI sensor strip S-Class / M-Class ASSY HI-LIMIT PROBE W/JST SSPA-MP







**Electronics & Packs**

PART NUMBER	DESCRIPTION	
01.03.05.0190	DH30-R1 Heater 220V-240V 3KW For Spa-Tech	
96.03.0098	H30-R1 Heater, 220-240V, 3KW for LX	
01.05.01.0022	Heater 3KW Model H30-R2 LX flow type	
9920-100345	Heater assembly - truHeat 825 Incoloy element : WAV MC-3.0KW-240-2-INC Inc. Pressure switch	
9920-100342	Heater assembly - truHeat 825 Incoloy element : WAV SSPA PACK C-3.0KW-240-2-INC Incl. Pressure switch	
9920-101438	HEAT.Assembly WAV-XE-2-240-2-INC-IF-T XE 2KW	
58118	Balboa heater Assembly 3.0 KW 800 15IN 2x2IN M7 incl. 2 sensors	

PART NUMBER	DESCRIPTION	
9920-401249	in.split cord - in.link (1) male LC x (2) female LC CABLE IN.SPLIT-LC-PP-5-120/240-AE1	

PART NUMBER	DESCRIPTION	
BDLTSC8GE1	TSC-8-GE1 AND OVERLAY Includes: TSC-8 keypad (0200-007113), for M-CLASS systems 0201-007171  Paragon TSC56  Can be replaced by BDLTSC8GE1	
9916-100130	Overlay TSC8, K8. also TSC56, 8 keys, 2 pumps, blower, light, filter, on/off, temp. up/down (9916-100239 old)	

PART NUMBER	DESCRIPTION	
BDLTSC19GE1	TSC-19-GE1 AND OVERLAY Includes: TSC-19 keypad (0202-007140),	
9916-100218	Overlay TSC19-GE-1 4 keys, 1 pump, light, Temp. up/down	



**Electronics & Packs**

PART NUMBER	DESCRIPTION
-------------	-------------

BDLTSC18PPD	TSC-18 AND OVERLAY KIT GE1-GE2 Includes: TSC-18 keypad (0202-007134), 1 pump overlay (9916-100239), 2 pumps overlay (9916-100240) / for S-CLASS systems
-------------	--



PART NUMBER	DESCRIPTION
-------------	-------------

9916-100240	TSC-18 GE2 OVERLAY (2 PUMPS) Overlay for TSC-18, 4 keys: 2 pumps, light, temperature up and down
-------------	--



PART NUMBER	DESCRIPTION
-------------	-------------

9916-100239	TSC-18 OVERLAY GE1 (1 PUMP) Overlay for TSC-18, 4 keys: 1 pump, light, temperature up and down
-------------	--



PART NUMBER	DESCRIPTION
-------------	-------------

BDLTSC19GE2	TSC-19-GE2 AND OVERLAY Includes: TSC-19 keypad (0202-007140), 2 pumps overlay (9916-100219) / for S-CLASS systems
-------------	---



PART NUMBER	DESCRIPTION
-------------	-------------

9916-100219	OVERLAY TSC-19-Overlay for TSC-19, 4 keys: 2 pumps, light, GE2 temperature up and down
-------------	--



PART NUMBER	DESCRIPTION
-------------	-------------

BDLTSC19GE1	tsc 19 control Pad , grey 4 key, LED display 1 pump overlay (9916-100218) / for S-CLASS systems
-------------	---



PART NUMBER	DESCRIPTION
-------------	-------------

9916-100218	OVERLAY TSC-19-GE1 Overlay for TSC-19, 4 keys: 1 pump, light, temperature up and down
-------------	---



PART NUMBER	DESCRIPTION
-------------	-------------

BDLTSC3GE1	TSC-3-GE1 AND OVERLAY Includes: TSC-3 auxiliary keypad (0200-007047), (9916-100261) / for M-CLASS systems
------------	---



9916-100261	Overlay TSC 3
-------------	---------------



**Electronics & Packs**

PART NUMBER	DESCRIPTION
-------------	-------------

BDLK4503OP	IN.K450-3OP AND OVERLAY Includes: in.k450 keypad (0607-005008), overlay (9916-101335) / for in.xe and in.xm 3 output systems
------------	--



9916-101335	Overlay IN.K450-3OP
-------------	---------------------

PART NUMBER	DESCRIPTION
-------------	-------------

BDLK1003OP	IN.K100 3OP AND OVERLAY Includes: in.k100 3 out. keypad (0607-009015), overlay (9916-101392) / for in.xm spa systems
------------	--



9916-101392	Overlay IN.K100 3OP
-------------	---------------------

PART NUMBER	DESCRIPTION
-------------	-------------

9920-400848	CABLE OUTPUT LIGHT 12VAC MSPA MTA-156-to-QC MC Pack adapter 9920-400848
-------------	---

PART NUMBER	DESCRIPTION
-------------	-------------

01.05.02.0008-D	IN .K450 Control Box Panel; Old part # 01.03.05.0128
-----------------	--



01.03.03.0243      [Overlay for Gecko control panel - IN .K450 -9916101335](#)

PART NUMBER	DESCRIPTION
-------------	-------------

01.05.02.0008-4	IN .K200 Control Box Panel Old part # 01.03.05.0111
-----------------	---



01.03.05.0111a	Overlay In.K200 Control panel
----------------	-------------------------------

PART NUMBER	DESCRIPTION
-------------	-------------

01.05.02.0008-1	IN .K600 Control Panel; Old part # 01.03.05.0102
-----------------	--



01.03.03.0242	Overlay In.K600
---------------	-----------------

BDLK600GF	IN.K600-GF Dark Grey AND OVERLAY Includes: in.k600 keypad with menu-driven interface (0607-007014), overlay (9916-101381) 11 buttons: /Function1 to 4/Left/Right/OK/+/-/Mode/Next Compatible with: in.xm, in.xm-2 systems
-----------	--







**FUSE**

PART NUMBER	DESCRIPTION	
430ad0057	Fuse FAST-ACTING 2A 250V 5X20MM	
430AC0117	FUSE FAST-ACTING 3AG 3A 250V	
430ad0036	Fuse Fast acting mini Transformer	
430ad0066	FUSE FAST-BLO 0.75A 250V 5X20MM	
430ad0103	Fuse Slo blo transformer	
430ac0092	FUSE SLO-BLO 3AG 1A 250V	
430ac0103	FUSE SLO-BLO 3AG 2A 250V	
430ae0027	FUSE TIME DELAY 20A 600V	
430ae0033	FUSE TIME DELAY 25A 300V	heater
430ad0084	Fuse Light	
430ad0024	FUSE TIME LAG 5A 250V 5X20MM	Ozonator, circ. pump, aux.
430ad0043	FUSE TIME LAG 6.3A 250V 5X20MM	Blower
430ac0069	FUSE TIME DELAY 3AG 10A 250V	
430ac0054	FUSE SLO-BLO 3AG 5A 250V	
430ac0222	FUSE FAST-ACTING 3AG 500MA 250V	
430ac0285	FUSE 250MA 3AG 250V SLOW-BLOW	transformer
430ae0069	FUSE EURO CLASS aM 20A 500V	Pump 1, Blower, Circulation Pump, Ozonator, Power Supply Pump 2, Heater
430ac0186	FUSE TIME DELAY 30A 480V	
430ae0051	FUSE EURO CLASS aM 16A 500V	Pump 1, Blower, Circulation Pump, Ozonator, UV, Power Supply Pump 2, Pump 3, heater

## Blowers

### Various

PART NUMBER	DESCRIPTION
-------------	-------------

01.03.05.0033 Blower - 700W Spa-Net 240V/50HZ/XS-10B  
(2.8m Power Line, AMP Terminal + Black Plug)



PART NUMBER	DESCRIPTION
-------------	-------------

01.03.05.0031 Blower - 400W 220-240V/50HZ/AP400  
2.8m Power Line, AMP Terminal + Shrinkable Tube



01.03.05.0243 400W Air Blower 220-240V2.4m In. Link /50HZ/AP400

PART NUMBER	DESCRIPTION
-------------	-------------

01.05.01.0312 Blower connection - 400W



PART NUMBER	DESCRIPTION
-------------	-------------

01.03.05.0089 UV sanitizer-SP- I /6000LPH (230V/50Hz)



01.03.03.0414 3/4British system coupling/S004-020020 - for UV sanitizer

PART NUMBER	DESCRIPTION
-------------	-------------

1203600001 OSBORN Acrylic repair and polishing set

L669002101 Unipol 1000ml Plastic polish

**NETTO**

PART NUMBER	DESCRIPTION
-------------	-------------

01.04.03.0029 Allseas swim pole - with package



01.04.02.0008 Allseas swim pole - without package



01.03.03.0335 Bag for swim pole pack



01.02.13.0043 SS Base for swim rod



01.03.06.0189 stainless steel swim base (whole set)/304#

**Various**

PART NUMBER	DESCRIPTION
-------------	-------------

Aqua-Finesse      ~~Complect set water threatment~~



PART NUMBER	DESCRIPTION
-------------	-------------

01.02.13.0048      ~~Plastic Sand Filter-P350(88011601) Old part#~~  
 01.03.03.0219



PART NUMBER	DESCRIPTION
-------------	-------------

01.03.03.0333      ~~Isolation Bag 40 cm x 70 cm x 3 cm~~

01.03.03.0334      ~~Isolation Bag 100 cm x 150 cm x 3 cm~~

PART NUMBER	DESCRIPTION
-------------	-------------

01.03.05.0080      Temperature Sensor B=3470,R25=5.1K,TLS-A02



01.05.01.0318      Balboa Temperature sensor 53605



PART NUMBER	DESCRIPTION
-------------	-------------

01.03.02.0001      LastingScents Essential Oil Pack Citrus Sorbet-green  
 01.03.02.0002      LastingScents Essential Oil Pack Pina Colada-grey  
 01.03.02.0003      LastingScents Essential Oil Pack Pina Colada-pearl grey  
 01.03.02.0004      LastingScents Essential Oil Pack Sandalwood spice-light  
                                  brown/tan  
 01.03.02.0005      LastingScents Essential Oil Pack Evening Musk-Dark brown  
 01.03.02.0006      LastingScents Essential Oil Pack Peach Passion-orange  
                                  peach  
 01.03.02.0007      LastingScents Essential Oil Pack Summer Orchard-red  
 01.03.02.0008      LastingScents Essential Oil Pack Wildflowers-purple  
 01.03.02.0009      LastingScents Essential Oil Pack Lavander-violet  
 01.03.02.0010      LastingScents Essential Oil Pack Eucalyptus-dark green



## Various

PART NUMBER	DESCRIPTION
-------------	-------------

01.03.03.0116 Aromatherapy Box without Perfume Bottle Pearl Gray



PART NUMBER	DESCRIPTION
-------------	-------------

01.03.06.0138 Cross head screw - Cabinet - for spa ST5\*55 S/S  
 01.03.06.0136 Hexagon screw - Cabinet - for swim spa M5\*55/304#  
 01.03.06.0168 Hexagon screw - Cabinet - for swim spa M8\*55/304#  
 01.03.06.0134 Stainless Steel Screw for Swim Spa Cabinet - M8\*50  
 01.03.06.0133 Flat head Nut - M8/304#  
 01.03.06.0132 Flat head Nut - M5/304#  
 01.03.03.0065 1" silica ring (φ38\*φ22\*2mm)  
 01.03.06.0090 S/S flat screw-M5x20/304#  
 01.03.06.0234 S/S sink head drilling screw ST4.8×38 410#-(black)  
 01.03.06.0251 S/S flat gasketφ6xφ20-(black)  
 01.03.06.0243 Screw for M8 flange inset - M3.5×16/410#  
 01.03.06.0242 M8 SS flange screw inset - for swim spa skirting M8/304

PART NUMBER	DESCRIPTION
-------------	-------------

01.04.03.0030 After sales service package



PART NUMBER	DESCRIPTION
-------------	-------------

01.03.09.0406 PS Foaming Skirting Panel -Light Grey-80\*10\*3200mm  
 01.03.09.0407 PS Foaming Skirting Corner Slate - Light Grey - 45\*10\*3200mm  
 01.03.09.0408 PS Foaming Skirting Strip - Light Grey-40\*10\*3200mm  
 01.05.01.0421 PS Foaming Skirting Corner Slate - dark grey - 45\*10\*3200mm  
 01.03.09.0529 PS Foaming Skirting Corner Slate - dark grey - 53\*10\*3200mm  
 01.03.09.0548 PS Foaming Skirting Corner Slate - dark grey - 53\*10\*1185mm  
 01.03.09.0528 PS Foaming Skirting Panel - Dark Grey-80\*10\*3200mm  
 01.03.09.0414 PS Foaming Skirting Panel - Brown-80\*10\*3200mm  
 01.03.09.0547 PS Foaming Skirting Panel - Dark Grey-80\*10\*1540mm



**Various**

PART NUMBER	DESCRIPTION
-------------	-------------

01.03.09.0530 PS Foaming Skirting Strip - Dark Grey-40\*10\*3200mm

01.03.09.0422 PS Foaming Skirting Strip - Brown-40\*10\*3200mm

01.03.09.0549 PS Foaming Skirting Strip - Dark Grey-40\*10\*1185mm

01.03.09.0507 PS Foaming Skirting Strip - Black -50\*20\*2700mm

01.03.09.0532 PS Foaming Skirting Strip - Black - 40\*12\*2700mm

PART NUMBER	DESCRIPTION
-------------	-------------

01.03.06.0083 Spanet air blower screw



PART NUMBER	DESCRIPTION
-------------	-------------

01.03.03.0185 1 1/2" Check valve



PART NUMBER	DESCRIPTION
-------------	-------------

01.03.03.0253 0.5 LB Water check valve (for dual flow filter system) 2"



PART NUMBER	DESCRIPTION
-------------	-------------

600-8140 Air Check Valve 1 1/2" S 2" Spg x 1 1/2" S-2











PART NUMBER	DESCRIPTION
-------------	-------------

98.01.0527 Spanner 1 1/2"

98.01.0528 Spanner 2"



## Pillows

PART NUMBER	DESCRIPTION	
01.03.03.0375	EVA Headrest-Trapeziform Old part # 01.05.02.0012	
PART NUMBER	DESCRIPTION	
01.03.03.0378	EVA Headrest-Crescent Old part # 01.05.02.0011	
PART NUMBER	DESCRIPTION	
01.03.03.0376	EVA Headrest- U-shape (Neck & Shoulder) Old part # 01.05.02.0013	
01.02.13.0082	EVA Headrest kit - U-shape (Neck & Shoulder)	
PART NUMBER	DESCRIPTION	
01.03.03.0377	EVA Headrest-Butterfly Old part #01.05.02.0016	
01.05.02.0026-9	EVA Headrest-Butterfly <b>with Allseas Spas Logo</b>	
01.05.02.0026-2	EVA Headrest-Butterfly <b>with customer logo</b>	
PART NUMBER	DESCRIPTION	
01.03.10.0531	Crystal LOGO - Allsea spas	
01.03.10.0412	Pillow LOGO - Allsea spas	
01.03.10.0596	Pillow LOGO - neutral label	
	Pillow LOGO - for customer	
	<b>New mode charge €37.5 needed for 1st order</b>	
PART NUMBER	DESCRIPTION	
01.05.02.0028	Universal Head Rest Pack - with connector and screw	
01.05.01.0413	Universal Head Rest-KM125A	
01.05.01.0414	Universal Head Rest Connector	
98.01.1250	S/S Screw for Universal Headrest - ST3.5*20	
PART NUMBER	DESCRIPTION	
01.05.02.0015	EVA Headrest— Fairy dream	

## Pillows

### Heat Pumps

PART NUMBER	DESCRIPTION	
01.05.02.0014	Crystal Headrest	

PART NUMBER	DESCRIPTION	
01.03.03.0305	Connector of EVA Headrest-Butterfly	

01.05.02.0021	Headrest Buckle	
---------------	-----------------	--

PART NUMBER	DESCRIPTION	
01.03.03.0304	Plastic Female Screw	

PART NUMBER	DESCRIPTION	
01.03.03.0085	EVA Headrest - Plug	
01.03.03.0086	EVA Headrest - Connector	

PART NUMBER	DESCRIPTION	
02.01.01.0001	Heatpump PA-050/R1U	
02.01.02.0001	Heatpump PA-100/R1U-P	
02.01.01.0012	Heatpump PA-140/R1U	

PART NUMBER	DESCRIPTION	
02.04.01.0001	Heat Pump pipe Assembly -2m	
02.04.01.0004	Heat Pump pipe Assembly -10m	

PART NUMBER	DESCRIPTION	
01.05.02.0018	1.5" heat pump plumbing connection kit	
02.03.04.0022	Heatpump sensor 5 meter wire	
02.03.04.0023	Heatpump sensor 10 meter wire	



Allseas Spas

Global market made!

Parts for all brands.